



The eBike Display
Users Manual

KD58C

Contents

Product name and model	1
Specifications	1
Appearance and Size	1
Function Summary and Button Definition	2
◆Function Summary	2
◆Button Definition	2
Assembly.....	2
Function Area Distribution	2
General Operation	2
◆Switching the eBike On/Off	2
◆Display Interface	2
◆Switching Push-assistance mode On/Off	3
◆Switching the Lighting On/Off.....	3
◆Assistance Level Selection.....	3
◆Power Indicator	4
◆Error code Indication.....	4
General Settings	4
◆Trip Distance Clearance	5
◆Unit Mi/KM Conversion	5
◆Wheel Diameter Settings.....	5
◆Speed-limit Settings	5
◆Battery Power bar Settings.....	6
Personalized Parameter Settings	6
◆Power Assistant Level Settings.....	6
Power Assistant Level option	6
PAS Ratio settings	7
◆Slowly Start up Settings.....	7
◆Power-on Password Settings	7
Power-on Password Enable/Disable	8
Power-on Password Modify	8
◆Exit settings	8
Recover default settings	8

Quality assurance and warranty scope.....	9
Connection layout.....	9
Operation Cautions	10

Product name and model

Electric bicycle intelligent display, model: KD58C.

Specifications

- 24V/36V /48V Power Supply
- Rated current: 10mA
- The maximum working current: 30mA
- Off leakage current: <1uA
- The supply controller working current: 50mA
- Working temperature: -20 ~ 60 °C
- Storage temperature: -30 ~ 70 °C

Appearance and Size

Display appearance and dimension figure (unit: mm)

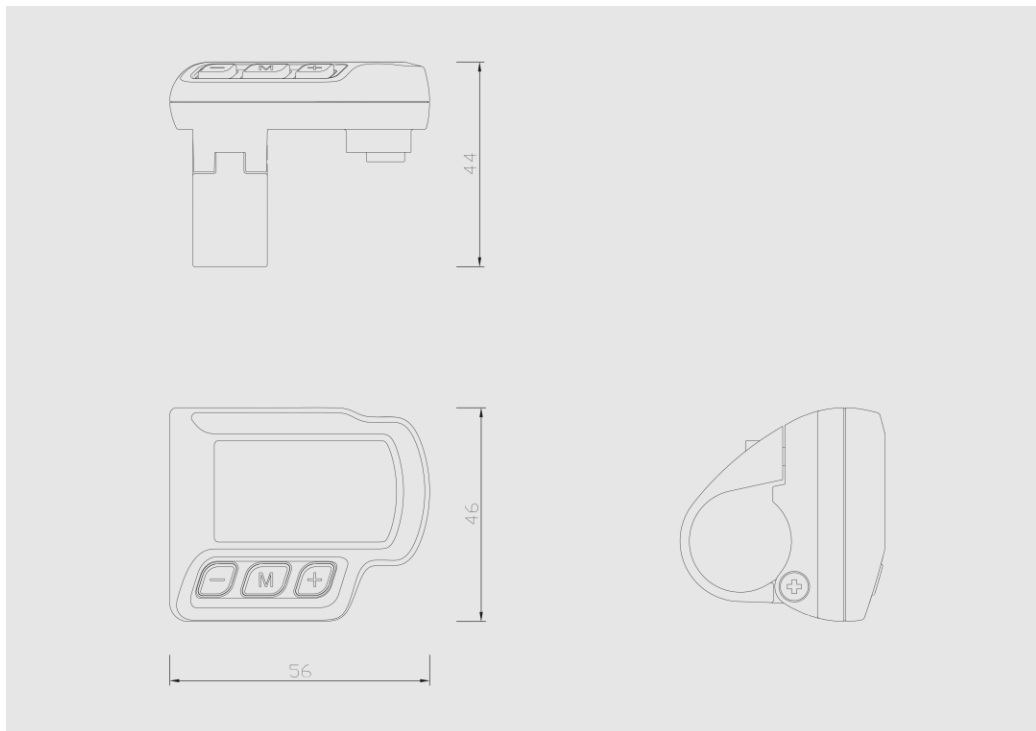

Function Summary and Button Definition

◆ Function Summary

KD58C can provide a lot of functions to fit the users' needs. The indicating contents are as following:

- Smart Battery indicator
- Assistance-level indication
- Speed indication (incl. running speed, max speed and average speed)
- Motor-output indicator
- Trip time indication
- Trip distance and Total distance
- The push-assistance function
- The Lighting On/Off
- Error Code indication
- Various Parameters Settings (e.g., wheel size, speed-limited, battery level bar, PAS level, password enable, controller limited current etc.)
- Recover Default Settings

◆ Button Definition

There are three buttons (**M**, **+**, **-**) on the KD58C display that represented by the following functions respectively: **MODE**, **UP** and **DOWN**.

Assembly

The KD58C display should be mounted on the handlebar between the left grip and the left brake clamp of the eBike at a comfortable angle. Cut off the power before connect the display to the controller.

Function Area Distribution

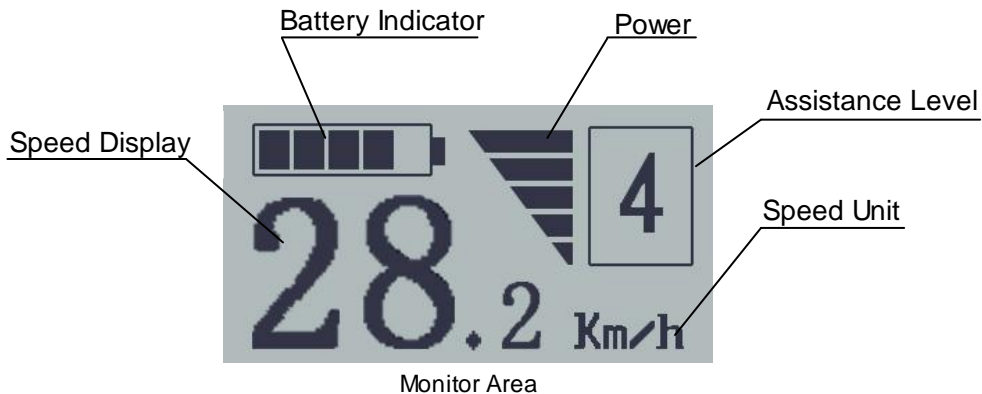

General Operation

◆ Switching the eBike On/Off

To switch on the eBike system, hold the **MODE** button for 2 s.

In the same way to hold the **MODE** button for 2 s again, the eBike system will be switched off.

When switching off the eBike system the leakage current is less than 1 uA.

■ When parking eBike for more than 10 minutes, the eBike system switches off automatically.

◆ Display Interface

After switching on the eBike system, the display shows Running Speed. On the condition of riding, to change the indicated information, press **MODE** to show in turn as below: Running Speed (Km/h) → Trip Distance (Km) → Trip Time (Hour) → Average

Speed (Km/h) → Max Speed (Km/h). Each state will display for 2 seconds and then automatically returns to the Running Speed interface. On the condition that the speed is 0 km/h, Total Distance will be added to the circulation interface.

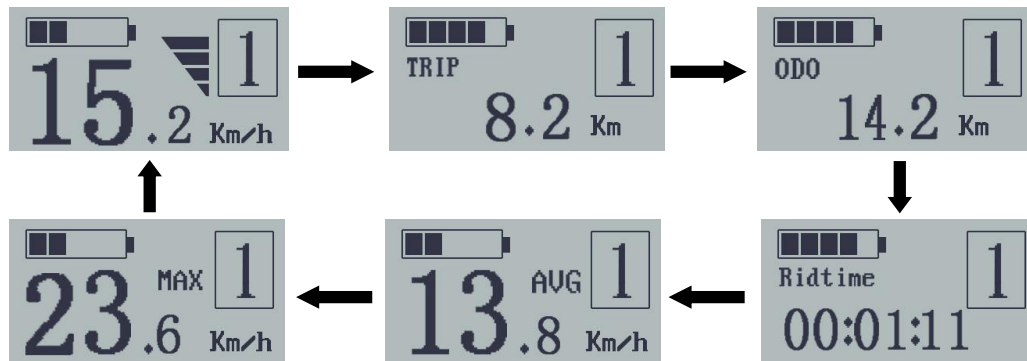

The circulation interface of the condition that the speed is 0 km/h

◆ Switching Push-assistance mode On/Off

To access the push-assistance mode, hold the **DOWN** button for 2 s, the eBike will go on at a uniform speed of 6 Km/h, “P” is showed on the screen at the same time. The push-assistance function switches off as soon as you release the **DOWN** button.

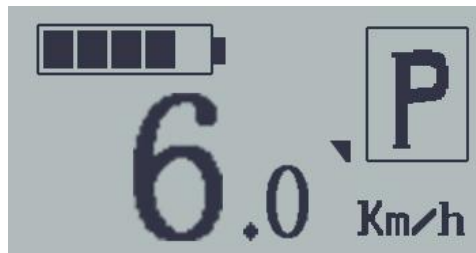

Push-assistance Mode

■ Push-assistance function may only be used when pushing the eBike. Danger of injury when the wheels of the eBike do not have ground contact while use the push-assistance function.

◆ Switching the Lighting On/Off

To switch on headlight of the eBike, hold the **UP** button for 2 s. In the same way to hold the **UP** button for 2 s again, the headlight will be switched off.

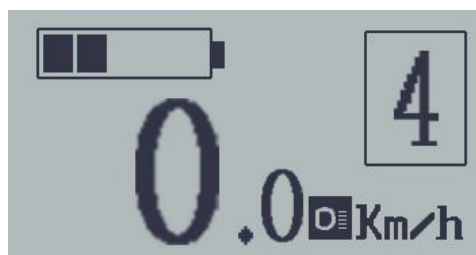

Switch On/Off the Lighting

◆ Assistance Level Selection

Assistance levels indicate the output power of the motor. The default value is level “1”.

The default power ranges from level “0” to level “5”. The output power is zero on Level “0”. Level “1” is the minimum power. Level “5” is the maximum power.



Assistance Level "4"

◆ **Power Indicator**

The out power of the motor can be indicated by the display.



Motor Power Indicator Interface

◆ **Error code Indication**

If there are errors about the electronic control system, the error code will appear automatically. Here is the message of the error code in **Attached list 1**.

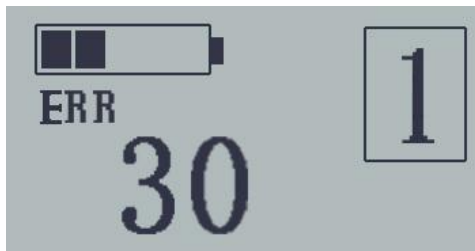

Error Code Indication

■ **Offer the display to a Service Center when an error code appears.**

General Settings

After the eBike system is switched on, to access general settings menu, hold both the **UP** and **DOWN** button for 2 s.

Press the **Up** or **DOWN** button to select the content, press **MODE** to confirm the corresponding settings.

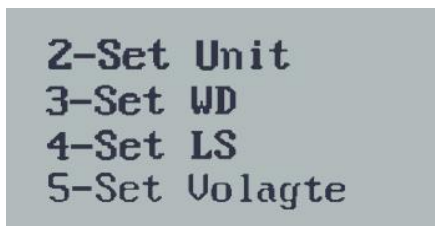
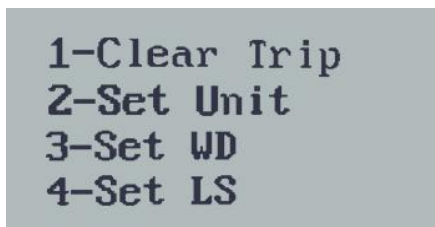

General selection settings interface

◆ **Trip Distance Clearance**

Clear Trip means single trip distance clearance. Press the **UP** or **DOWN** button to choose YES or NO to clear the trip distance. The default value is NO. If you choose YES and press the **MODE** button to confirm the option, the display will show OK and return to the general selection settings interface. Otherwise the display will return to the general selection settings interface directly.

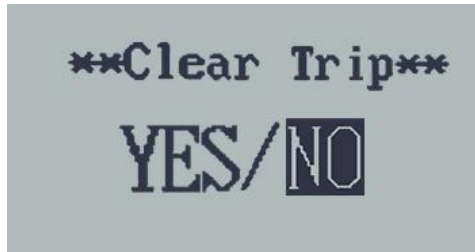

Trip distance clearance

◆ **Unit Mi/KM Conversion**

Set Unit represents unit settings.

To convert unit, press **UP/DOWN** to increase or decrease until the desired setting is displayed.

To store a changed setting, press the **MODE** button to access trip distance clearance settings and the display will show OK then returns to general selection settings interface. The default value is Metric.



Mile and Kilometer Conversion Settings Interface

◆ **Wheel Diameter Settings**

Set WD represents wheel diameter settings. Electable values are 16, 18, 20, 22, 24, 26, 700C and 28. The default value is 26 inch.

To change basic settings, press **UP/DOWN** to increase or decrease until the desired value is displayed.

To store a changed setting, press the **MODE** button and the display will show OK then returns to general selection settings interface.



Wheel Diameter Settings Interface

◆ **Speed-limit Settings**

Set LS represents limit speed settings. When the running speed is faster than limit speed, the eBike system will switch off automatically. Limit speed range is 12Km/h to 40Km/h. The default value is 25Km/h.

To change basic settings, press **UP/DOWN** to increase or decrease until the

desired value is displayed.

To store a changed setting, hold **MODE** for 2 s and the display will display OK then returns to general selection settings interface.



Limit Speed Settings Interface

◆ Battery Power bar Settings

VOL represents voltage settings. Each bar represents a voltage value. 5 bars voltage values must be entered one by one. For example, VOL 1 is the first bar voltage value, the default value is 31.5V.

To set battery power bar, press **UP/DOWN** to increase or decrease the number.

To store a changed setting and access the second bar, press the **MODE** button.

By analogy, after 5 bars voltage values is entered, hold **MODE** for 2 s to confirm and return to the previous menu.



Battery Power Bar Settings

Personalized Parameter Settings

Personalized Parameter Settings can match various requirements in use. T

Hold the **UP** and **DOWN** button for 2 s to enter general settings, then use the same manner to enter personalized parameter settings selection interface. Press the **UP** or **DOWN** button to choose the personalized parameter settings items, then press the **MODE** button to enter the corresponding settings interface.

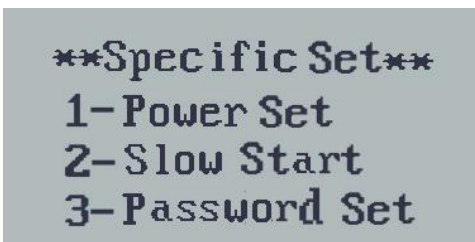

Personalized parameter settings Interface

◆ Power Assistant Level Settings

Power Assistant Level option

In assistance level settings, there are 8 modes to select: 0-3, 1-3, 0-5, 1-5, 0-7, 1-7, 0-9, 1-9. The default value is 0-5.

To select the mode of assistance level, press **UP/DOWN** to increase or decrease until the desired setting is displayed.

To store the changed setting and access the PAS ratio settings page, press the **MODE** button.

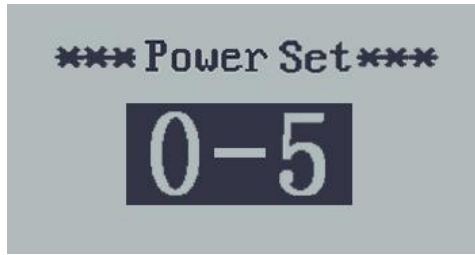

PAS Mode option Interface

PAS Ratio settings

To modify the value of PAS ratio can match the different requirements.

For example, the range is "45-55 percent" of 1 level, bottom value can be modified and the default is 50 percent.

Press the **UP** or **DOWN** button to increase or decrease the number. Press the **MODE** button to confirm and turn to the next PAS ratio settings. 9 levels is the maximum. After all PAS ratio inputted, press the **MODE** button to confirm and return to general selection settings interface. Various symbol definitions please refer to **Attached list 2**.



PAS Ratio Interface

◆ Slowly Start up Settings

Slow Start represents slowly start up. The range is 1-4, 4 is the slowest.

To change slowly start up settings, press the **UP** or **DOWN** button to select, press the **MODE** button to confirm and the meter will display OK then return to general selection settings interface. The default value is 1.



Interface of slowly settings up

◆ Power-on Password Settings

P2:0000 represents power-on password settings. The default value is 1212.

To access the power-on password settings, press **UP/DOWN** to modify the value and then press **MODE** to confirm digit one by one until the correct 4-digit password is completed, and then press **MODE** to access power-on password enable settings interface, otherwise stay on the password input state.



Power-on Password Entering Interface

Power-on Password Enable/Disable

Press the **MODE** button to enter power-on password modify interface. Press the **UP** or **DOWN** button to select Disable or Enable and press the **MODE** button to confirm. The default value is Enable. If you choose Enable, press the **MODE** button to enter Power-on Password Modify interface, otherwise exit the power-on password settings interface.



Power-on Password Disable/Enable Interface

Power-on Password Modify

When the display shows "Password Set, P3", press the **UP** or **DOWN** button to modify the value and then press the **MODE** button to confirm digit one by one until the new 4-digit password is completed.

To store the new power-on password, hold the **MODE** button for 2 s and then exit settings.

When switching the eBike system on next time, the display will show P1,0000, please input the new password to power on.



Power-on Password Modify Interface

◆ Exit settings

In the settings state, press the **MODE** button to confirm the input. Hold the **MODE** button for 2 s to save the settings and then exit the current settings. Hold the **DOWN** button for 2 s to cancel the operating but not saving the settings data, and then return to previous menu.

■ If there is not any operations in one minute, display will exit the settings state automatically.

Recover default settings

DEF means recover default settings. Press both the **UP** and **MODE** button for 2 s to enter recover default settings. Press the **UP** or **DOWN** button to choose Y or N. Y means that recovers default settings. N means that do not recover default settings. When it is Y,

hold the **MODE** button for 2 s to recover default settings, the display shows dEF-00 at the same time, and then return to general display state. The default value is N.

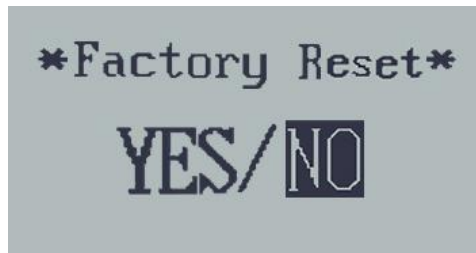

Recover Default Settings Interface

Quality assurance and warranty scope

I Warranty

- 1) The warranty will be valid only for products used in normal usage and conditions.
- 2) The warranty is valid for 24 months after the shipment or delivery to the customer.

II Others

The following items do not belong to our warranty scope.

- 1) The display is demolished.
- 2) The damage of the display is caused by wrong installation or operation.
- 3) Shell of the display is broken when the display is out of the factory.
- 4) Wire of the display is broken.
- 5) Beyond Warranty period.
- 6) The fault or damage of the display is caused by the force majeure (e.g., fire, earthquake, etc.).

Connection layout

Connector line sequence

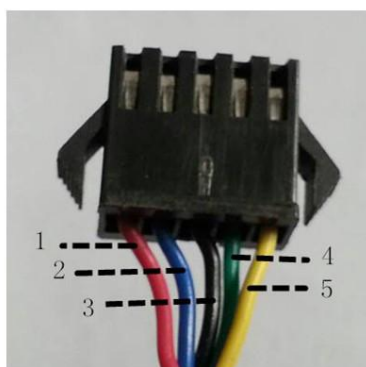

Display-side Connector

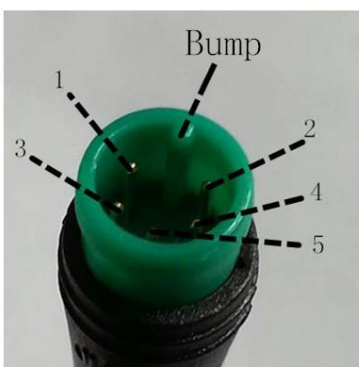

Display-side adapter

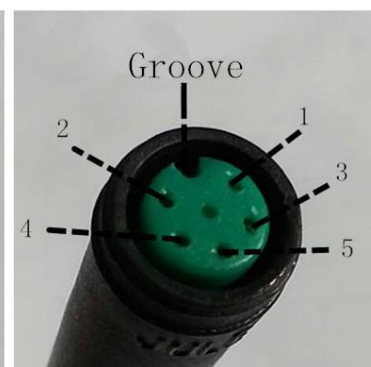

Switch wiring

Line sequence table

Line sequence	Color	Function
1	Red (VCC)	+
2	Blue(K)	Lock
3	Black(GND)	-
4	Green(RX)	RX
5	Yellow(TX)	TX

■Some wire use the water-proof connector, users are not able to see the inside color.

Operation Cautions

Be care of the safety use. Don't attempt to release the connector when battery is on power.

- ◆ Try to avoid hitting.
- ◆ Do not modify system parameters to avoid parameters disorder.
- ◆ Make the display repaired when error code appears.

Attached list 1: Error code definition

Error Code	Definition
21	Current Abnormality
22	Throttle Abnormality
23	Motor Abnormality
24	Motor Hall Abnormality
25	Brake Abnormality
30	Communication Abnormality

Attached list 2: Power assist table

Level Item	1	2	3	4	5	6	7	8	9
0-3/1-3	50%	74%	92%	—	—	—	—	—	—
0-5/ 1-5	50%	61%	73%	85%	96%	—	—	—	—
0-7/ 1-7	40%	50%	60%	70%	80%	90%	96%	—	—
0-9/ 1-9	25%	34%	43%	52%	61%	70%	79%	88%	96%